

# RTi S E R I E S

**RTi100**  
Floorstanding Loudspeaker

**Owner's  
Manual**

**polk**audio  
the speaker specialists®

## **SAFETY PRECAUTIONS— READ FIRST!**

### **1. Read the instructions.**

All the safety and operating instructions should be read before the product is operated.

### **2. Retain instructions.**

Safety and operating instructions should be retained for future reference.

### **3. Heed warnings.**

All warnings on the product and in the operating instructions should be adhered to.

### **4. Follow instructions.**

All operating and use instructions should be followed.

### **5. Water and moisture.**

Product should not be used near water—for example, near a bathtub, washbowl, kitchen sink, laundry tub, in a wet basement, or near a swimming pool, etc.

### **6. Accessories.**

Do not place this product on an unstable cart, stand, tripod, bracket, or table. The product may fall, causing serious injury to a child or adult, and serious damage to the product. Use only with a cart, stand, tripod, bracket, or table recommended by the manufacturer or sold with the product. Any mounting of the product should follow the manufacturer's instructions, and should use a mounting accessory recommended by the manufacturer.

### **7. Wall or ceiling mounting.**

Product should be mounted on a wall or ceiling only when and as recommended by the manufacturer.

### **8. Ventilation.**

Cooling fins on the rear of the amplifier are provided for ventilation, to ensure reliable operation of the product, and to protect it from overheating. Fins must not be blocked or covered. The fins should never be blocked by placing product on a bed, sofa, rug, or other similar surface. This product should not be placed in a built-in installation such as a bookcase or rack unless proper ventilation is provided or the manufacturer's instructions have been adhered to.

### **9. Heat.**

Product should be situated away from heat sources such as radiators, heat registers, stoves, or other products that produce heat. If placed near an amplifier, check with manufacturer for applicability.

### **10. Power sources.**

This product should be operated only from the type of power source indicated on the marking label. If you are not sure of the type of power supply to your home, consult your product dealer or local power company.

### **11. Grounding or polarization.**

This product may be equipped with a polarized alternating current line plug (a plug having one blade wider than the other). This plug will fit into the power outlet only one way. This is a safety feature. If you are unable to insert the plug fully into the outlet, try reversing the plug. If the plug should still fail to fit, contact your electrician to replace your obsolete outlet. Do not defeat the safety purpose of this polarized plug.

### **12. Power cord protection.**

Power-supply cords should be routed so that they are not likely to be walked on or pinched by items placed upon or against them, paying particular attention to cords at plugs, convenience receptacles, and the point where they exit from the product.

### **13. Cleaning.**

Unplug this product from the wall outlet before cleaning. Do not use liquid cleaners or aerosol cleaners. Use a damp cloth for cleaning.

### **14. Nonuse periods.**

The cord of the product should be unplugged from the outlet when left unused for long periods of time.

### **15. Lightning.**

For added protection for this product during a lightning storm, or when it is left unattended and unused for long periods of time, unplug it from the wall outlet and disconnect the antenna or cable system. This will prevent damage to the product due to lightning and power-line surges.

### **16. Overloading.**

Do not overload wall outlets, extension cords, or integral convenience receptacles as this can result in a risk of fire or electric shock.

### **17. Object and liquid entry.**

Never push objects of any kind into this product through openings as they may touch dangerous voltage points or short out parts that could result in fire or electric shock. Never spill liquid of any kind on the product.

### **18. Damage requiring service.**

Unplug this product from the wall outlet and refer servicing to qualified service personnel under the following conditions:

- Power supply cord or plug has been damaged.
- Objects have fallen into, or liquid has spilled into, the product, or
- Product has been exposed to rain or water, or
- Product does not operate normally when following operating instructions. Adjust only those controls that are covered by the operating instructions, as an improper adjustment of other controls may result in damage and will often require extensive work by a qualified technician to restore the product to its normal operation; or
- Product has been dropped, or enclosure damaged; or
- Product does not appear to operate normally or exhibits a marked change in performance.

### **19. Attachments.**

Do not use attachments not recommended by the product manufacturer as these may cause hazards.

### **20. Replacement parts.**



When replacement parts are required, be sure the service technician has used replacement parts specified by the manufacturer or that have the same characteristics as the original part. Unauthorized substitutions may result in fire, electric shock, or other hazards.

### **21. Safety check.**

Upon completion of any service or repairs to this product, ask the service technician to perform safety checks to determine that product is in proper operating condition.


### **22. Servicing.**

Do not attempt to service this product yourself as opening or removing covers may expose you to dangerous voltage or other hazards. Refer all servicing to qualified service personnel.


**CAUTION**  
RISK OF ELECTRIC SHOCK  
DO NOT OPEN

AVIS: RISQUE DE CHOC ÉLECTRIQUE. NE PAS OUVRIR.

**WARNING**  
TO REDUCE THE RISK OF FIRE OR ELECTRIC SHOCK,  
DO NOT EXPOSE THIS APPLIANCE TO RAIN OR MOISTURE.  
NO USER SERVICEABLE PARTS INSIDE. REFER SERVICING  
TO QUALIFIED SERVICE PERSONNEL.



The lightning flash with arrowhead symbol, within an equilateral triangle, is intended to alert the user to the presence of uninsulated "dangerous voltage" within the product's enclosure that may be of sufficient magnitude to constitute a risk of electric shock to persons.



The exclamation point within an equilateral triangle is intended to alert the user to the presence of important operating and maintenance (servicing) instructions in the literature accompanying the appliance.

**WARNING**  
TO REDUCE THE RISK OF ELECTRIC SHOCK, DO NOT  
EXPOSE THIS APPLIANCE TO RAIN OR MOISTURE.

**CAUTION: TO PREVENT ELECTRIC SHOCK, MATCH  
WIDE BLADE OF PLUG TO WIDE SLOT, FULLY INSERT.**

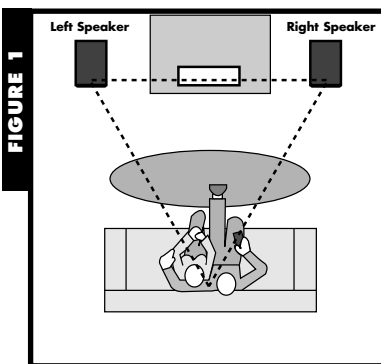
**ATTENTION: POUR ÉVITER LES CHOCS ÉLEC-  
TRIQUES INTRODUIRE LA LAME LA PLUS LARGE DE  
LA FICHE DANS LA BORNE CORRESPONDANTE DE  
LA PRISE ET POUSSER JUSQU'AU FOND.**

## POLK AUDIO—A PASSION FOR SOUND

Thank you for purchasing this Polk Audio loudspeaker. Since its start in 1972, Polk Audio has been dedicated to audio products that emphasize superior sound and build quality, as well as an ever-evolving standard for performance. It's our mission to provide these great products at a reasonable price for the enjoyment of people like you, who love good sound. Our thirty years of R&D, resulting in over 45 worldwide patents for loudspeaker technology and innovation, has solidified our reputation as "The Speaker Specialists," and demonstrated that for the people here at Polk Audio, building speakers is not just a job; it's a *passion*. Welcome to the Polk Audio family!

### PLACEMENT RECOMMENDATIONS FOR RTi SERIES FLOORSTANDING LOUDSPEAKERS

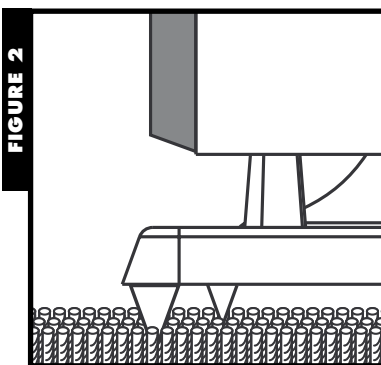
To get the most realistic stereo image and lifelike sound, place the speakers so that an equilateral triangle is created between the speakers and your favorite listening position [figure 1]. Your RTi Series Loudspeakers are magnetically shielded for safe placement near your TV or video monitor. If you notice video distortion or discoloration, immediately move the speakers away from the TV and call Polk Audio Customer Service 800-377-7655 (US and Canada) or polkcs@polkaudio.com. If your room arrangement forces you to place the speakers farther apart than the distance from which you are listening, angle the speakers toward the middle in order to support a more solid center image. Rubber feet and adjustable carpet spikes are included to provide stability on any type of floor. To install them, lay the speaker carefully on its side and screw in the spikes as far as they will go into the threaded inserts in the base of the speaker. For wood or tile floors, slip a rubber foot over each spike. For carpeted floors, use bare spikes [figure 2]. You will achieve optimum performance when the speaker is level and stable in all directions.



**FIGURE 1**  
**Create an equilateral triangle between the speakers and the listening position.**  
**RTi Series Loudspeakers are magnetically shielded for safe placement near TV or video monitors.**  
**If you notice video distortion or discoloration, immediately move the speakers away from the video source and call Polk Audio Customer Service 800.377.7655 (US and Canada) or polkcs@polkaudio.com.**  
**Haga un triángulo equilátero con los altavoces y la posición de audición.**

**Créez un triangle équilatéral entre les enceintes et la position d'écoute.**

**Bilden Sie ein Dreieck zwischen den Lautsprechern und Ihrer Hörposition.**



**FIGURE 2**  
**For stability on carpet, use spikes. For stability on hard floors, use rubber feet over spikes.**

**Use púas para estabilizar los altavoces sobre una alfombra.**  
**Use patas de goma sobre las púas para estabilizarlos sobre pisos duros.**

**Pour plus de stabilité sur tapis, utilisez les picots.**  
**Sur planchers, recouvrez les picots des pieds de caoutchouc.**

**Die Verwendung von Befestigungsstutzen gewährleistet die Stabilität der Lautsprecher bei Platzierung auf Teppichböden. Auf hartem Untergrund sollten die Stutzen mit Gummifüßen überzogen werden.**

---

## **CONNECTION OPTIONS FOR RTI SERIES FLOORSTANDING LOUDSPEAKERS**

Follow the hookup directions included with your receiver. Strip 1/2 inch (12.7mm) of insulation from each of the two conductors of the speaker wire to expose the bare metal and twist each of the individual conductors into single unfrayed strands. Note that one of the terminals on the rear of each speaker is red (+) and the other is black (-). Make certain that you connect the wire from the red (+) terminal of your amplifier or receiver to the red (+) terminal on your speaker and the wire from the black (-) terminal of your amplifier or receiver to the black (-) terminal on your speaker. Most wire has some indicator (such as color-coding, ribbing or writing) on one of the two conductors to help you maintain consistency.

To connect wire to the binding post **[figure 3]**, unscrew the hex nut and insert the bare wire into the hole near the base of the binding post. Do not insert the insulated part of the wire into the hole as this will not give you a good connection. Twist the hex nut back down the binding post until it firmly meets the wire. Do not over tighten.

**To Use Banana Plugs (US Only):** Unscrew the binding post lug nuts completely to expose the binding post plugs (plastic plugs inserted into the binding posts). Carefully pry out the binding post plugs to expose banana plug holes. Screw the lug nuts back on the binding posts and insert banana plugs. (This is for US owners only.)

**HOOK UP OPTION 1 [figure 4]** is recommended for most systems. Make sure the flat metal jumper strips are tightly secured to both sets of binding posts.

**HOOK UP OPTION 2 [figure 5]** is recommend for use with a receivers or preamp/processors with L & R preamp outputs. For this connection, remove the flat metal jumper strips. Connect the top set of binding posts to the speaker outputs of your amp or receiver. If your pre-amp, processor, amplifier or receiver has a spare set of front left and right pre-outputs, connect them to the subwoofer inputs on the back of the speakers. If your electronics has a single set of pre-outputs and they are being used to deliver signal to an amplifier, use "Y" cables.

**HOOK UP OPTION 3 [figure 6]** is recommended for systems with receivers or preamp/processors with unfiltered subwoofer (LFE) outputs only. (To find out if your subwoofer output jack is unfiltered, please see your receiver/preamp/processor's owner's manual.) For this connection, remove the flat metal jumper strips. Connect the line level inputs on the back of the loudspeaker to the subwoofer output(s) of your pre-amp, processor, amplifier or receiver. If you only have one subwoofer output jack, run a cable to the subwoofer line level input of one speaker and another cable from the line level output of that speaker to the line level input of the other speaker.

If you are not sure about the nature of your subwoofer output jack, use either hookup option 1 or hookup option 2.

**FOR MANUAL UPDATES, VISIT**

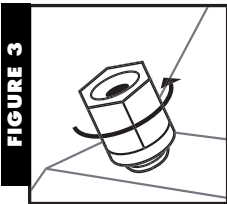
<http://www.polkaudio.com/home/products/floorstanding/rti25>

**FOR MORE DETAILED HOOKUP AND PLACEMENT INFORMATION, VISIT**

<http://www.polkaudio.com/home/faqad/>

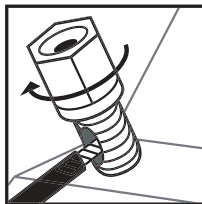
**FOR RECOMMENDED ACCESSORIES (INCLUDING SPEAKER STANDS, BRACKETS AND EXCLUSIVE POLK AUDIO LOGOWEAR), VISIT OUR WEBSTORE:**

<http://shop.polkaudio.com/>

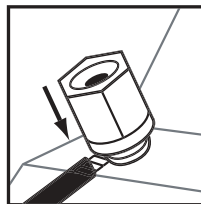


**FIGURE 3**

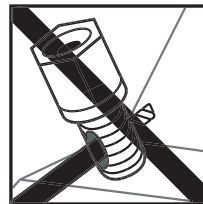
**Loosen hex nut**  
 Desenrosque parcialmente la tuerca hexagonal  
 Desserrer l'écrou  
 Sechskantmutter lösen



**Insert speaker wire through hole**  
 Inserte el alambre para la bocina en el orificio  
 Insérer le fil du haut-parleur dans le trou  
 Lautsprecher-Draht durch das Loch schieben



**Tighten hex nut**  
 Enrosque la tuerca de nuevo  
 Serrer l'écrou  
 Sechskantmutter festschrauben



**Do not insert insulated section of speaker wire**  
 No inserte alambre con material aislante  
 Ne pas insérer la partie isolée du fil du haut-parleur  
 Isolation des Lautsprecher-Drahtes nicht in das Loch schieben

**FIGURE 3**

Using binding post connections.

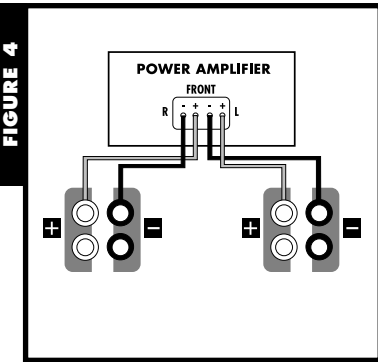
Uso de conexiones con tornillos de presión.

Utilisation des bornes de branchement.

Verwendung von Anschlussklemmen.

**To use Banana Plugs (US only):**

Unscrew the binding post lug nuts completely to expose the binding post plugs (plastic plugs inserted into the binding posts). Carefully pry out the binding post plugs to expose banana plug holes. Screw the lug nuts back on the binding posts and insert banana plugs. (This is for US owners only.)



**FIGURE 4**

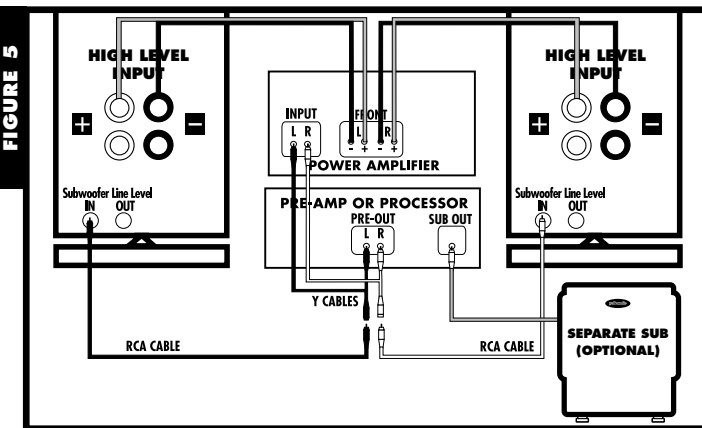
**FIGURE 4**

Option 1, recommended for most systems.  
**BASS MANAGEMENT SETTINGS: Front = Large**

Opción 1, recomendada para la mayoría de los sistemas.  
**PARÁMETROS DE CONTROL DE BAJAS FRECUENCIAS: Front = Grande (Large)**

Option 1, recommandée pour la plupart des systèmes.  
**Réglages: (Bass Management Settings) Front (avant) = Large**

Option 1, empfohlen für die meisten Lautsprecher.  
**EINSTELLUNG DER TIEFENTONLAGEN: Vorne = Groß**



**FIGURE 5**

**FIGURE 5**

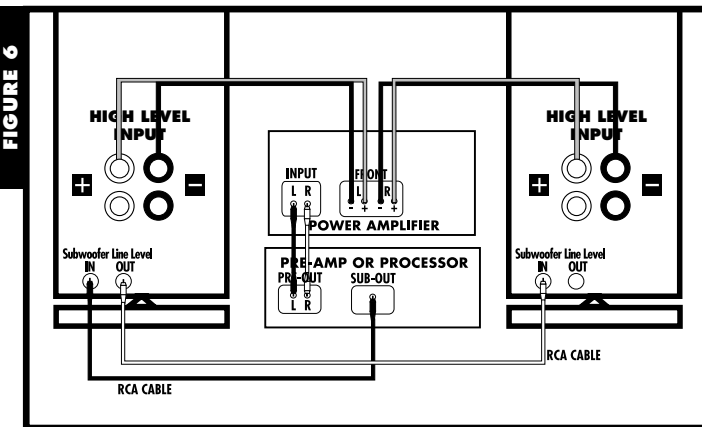
Option 2, for systems with preamp outputs.

**BASS MANAGEMENT SETTINGS:**  
 With NO separate subwoofer: Front = Large Sub = No  
 WITH separate sub: Front = Large Sub = Yes

Opción 2, para sistemas con salidas de preamplificador.  
**PARÁMETROS DE CONTROL DE BAJAS FRECUENCIAS:**  
 2a: Front = Grande (Large) Sub = No  
 2b: Front = Grande (Large) Sub = Sí

Option 2, pour systèmes avec sorties préamplificateur.  
**RÉGLAGES: (BASS MANAGEMENT SETTINGS)**  
 2a: Front (avant) = Large Sub = No  
 2b: Front (avant) = Large Sub = Yes

Option 2, für Systeme mit Vorverstärker-Ausgängen.  
**EINSTELLUNG DER TIEFENTONLAGEN:**  
 2a: Vorne = Groß Subwoofer = Keine  
 2b: Vorne = Groß Subwoofer = Ja



**FIGURE 6**

**FIGURE 6**

Option 3, for systems with both unfiltered subwoofer outputs and no separate dedicated sub.

**BASS MANAGEMENT SETTINGS:**  
 Front = Small Sub = Yes

Opción 3, para sistemas con ambas salidas de subwoofer sin filtrar y sin subwoofer dedicado separado.  
**PARÁMETROS DE CONTROL DE BAJAS FRECUENCIAS:**  
 Front = Pequeño (Small) Sub = Sí

Option 3, pour systèmes avec deux sorties subwoofer sans filtre et sans sortie subwoofer dédiée distincte.  
**RÉGLAGES: (BASS MANAGEMENT SETTINGS):**  
 Front = Small Sub = Yes

Option 3, für Systeme sowohl mit nicht gefilterten Subwoofer-Ausgängen als auch ohne separaten (dedizierten) Subwoofer.  
**EINSTELLUNG DER TIEFENTONLAGEN:**  
 Vorne = Klein Subwoofer = Ja

---

### **SETTING THE VOLUME**

Volume level for the built-in subwoofer is adjusted using the volume control knob located on the rear plate of the amplifier **[figure 7]**. Set this control by ear using a wide variety of music and movie sources.

### **SAFE LIMITS OF OPERATION**

Your Polk loudspeakers are made with the highest quality materials for years of trouble-free performance. However, damage to loudspeakers can occur when an amplifier, regardless of its wattage, is made to play at higher listening levels than its power can clearly produce (usually beyond the “1 to 2 o'clock” position on the volume control). This results in very high levels of audible distortion, originating in the amplifier, that can add a harsh, gritty sound to music. Contrary to popular belief, a speaker is more likely to be damaged by trying to get too much volume from a low-powered amp or receiver than from a high powered one.

### **AC POWER**

This RTi powered loudspeaker has a built-in power amplifier and must be plugged into a standard household AC power source in order to operate properly.

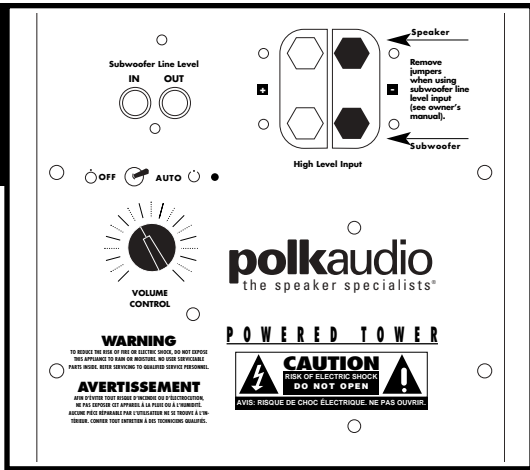
The power switch on the rear amp plate **[figure 7]** has two positions, “Off” and “Auto,” and a small LED light. The LED will glow green at all times that the powered loudspeaker is plugged in (even if the speaker is set to “Off”). We meant it that way.

To play, set the switch in the “Auto” position. Set to the “Auto” position, the amplifier will automatically turn on as soon as the speaker senses a signal coming from your pre-amp, integrated amp or receiver. It will automatically turn off several minutes after signals cease to be sent by your pre-amp, integrated amp or receiver. The LED will glow green at all times.

### **TAKING CARE OF YOUR RTi SERIES FLOORSTANDING LOUDSPEAKERS**

Avoid harsh detergents and cleaning fluids **[figure 8]**. Clean and dust the veneer with a damp cloth only. Do not use furniture polish on the veneer. Carefully vacuum the grilles to remove dust.

**FIGURE 7**



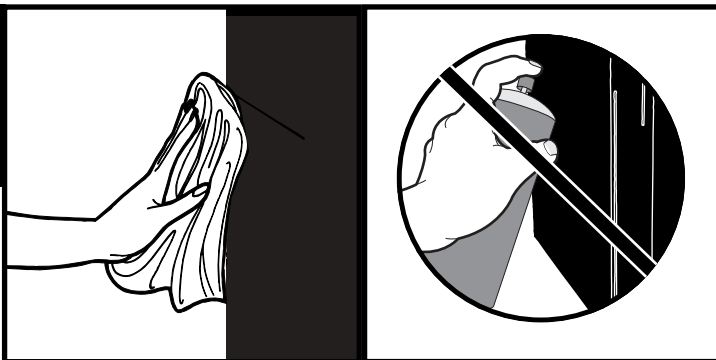
**FIGURE 7**  
**RTi powered loudspeaker Amplifier panel**

**Tablero del Amplificador para la bocina RTi de potencia**

**Enceinte amplifiée panneau de l'amplificateur**

**Rückseite des aktiven RTi Lautsprechers**

**FIGURE 8**



**FIGURE 8**  
**Clean veneer with a damp cloth. Do not use furniture polish.**

**Cuidado del acabado de madera natural.**

**Entretien de la finition en bois véritable.**

**Pflege der Holzappretur.**

## LIMITED FIVE YEAR WARRANTY

Polk Audio, Inc. warrants to the original purchaser only that this Polk Audio Loudspeaker Product (the "Product") will be free from defects in materials and workmanship for a period of five (5) years from the date of original retail purchase from a Polk Audio Authorized Dealer. However, this Warranty will automatically terminate prior to the expiration of the five (5) years if the original retail purchaser sells or otherwise transfers the Product to any other party. The original retail purchaser shall hereinafter be referred to as "you." To allow Polk Audio to offer the best possible warranty service, please fill out the Product Registration Card(s) and send it to the Factory, at the address provided on the Product Cards(s) within ten (10) days of the date of purchase.

Defective Products must be shipped, together with proof of purchase, prepaid insured to the Polk Audio Authorized Dealer from whom you purchased the Product, or to the Factory at 2550 Britannia Boulevard, Suite D, San Diego, California 92154. Products must be shipped in the original shipping container or its equivalent; in any case the risk of loss or damage in transit is to be borne by you. If upon examination at the Factory or Polk Audio Authorized Dealer it is determined that the unit was defective in materials or workmanship at any time during this Warranty period, Polk Audio or the Polk Audio Authorized Dealer will, at its option, repair or replace this Product at no additional charge, except as set forth below. All replaced parts and Products become the property of Polk Audio. Products replaced or repaired under this warranty will be returned to you, within a reasonable time, freight prepaid.

This warranty does not include service or parts to repair damage caused by accident, disaster, misuse, abuse, negligence, inadequate packing or shipping procedures, commercial use, voltage inputs in excess of the rated maximum of the unit, cosmetic appearance of cabinetry not directly attributable to defect in materials or workmanship, or service, repair, or modification of the Product which has not been authorized or approved by Polk Audio. This warranty shall terminate if the Serial number on the Product has been removed, tampered with or defaced.

This warranty is in lieu of all other expressed Warranties. If this Product is defective in materials or workmanship as warranted above, your sole remedy shall be repair or replacement as provided above. In no event will Polk Audio, Inc. be liable to you for any incidental or consequential damages arising out of the use or inability to use the Product, even if Polk Audio, Inc. or a Polk Audio Authorized Dealer has been advised of the possibility of such damages, or for any claim by any other party. Some states do not allow the exclusion or limitation of consequential damages, so the above limitation and exclusion may not apply to you.

All implied warranties on this Product are limited to the duration of this expressed Warranty. Some states do not allow limitation on how long an implied Warranty lasts, so the above limitations may not apply to you. This Warranty gives you specific legal rights, and you also may have other rights which vary from state to state.

This Warranty applies only to Products purchased in the United States of America, its possessions, and U.S. and NATO armed forces exchanges and audio clubs. The Warranty terms and conditions applicable to Products purchased in other countries are available from the Polk Audio Authorized Distributors in such countries.

---

## SPECIFICATIONS

### RT100

#### DRIVER COMPLEMENT:

6½"(16.5cm) driver  
1"(2.5cm) tweeter  
6½"(16.5cm) subwoofer

#### OVERALL FREQUENCY RESPONSE:

25Hz-27kHz

#### -3DB LIMITS:

36Hz-26kHz

#### RECOMMENDED AMPLIFICATION:

20-250 watts/channel

#### IMPEDANCE:

Compatible with 8 Ohm Outputs

#### SUBWOOFER POWER OUTPUT (DYNAMIC):

35 watts

#### SUBWOOFER POWER OUTPUT (FTC):

80 watts

#### CROSSOVER FREQUENCY:

85Hz, 2.1k

#### CROSSOVER SLOPE:

2nd Order HP, 2nd Order LP

#### ENCLOSURE TYPE:

Driver Sealed/Subwoofer Bandpass PowerPort

#### DIMENSIONS:

43¼"H x 8¼"W x 11¾"D  
(109.9cmH x 20.9cmW x 28.9cmD)

#### BASE DIMENSIONS:

9"W x 12¼"D  
(22.9cmW x 31.1cmD)

#### SHIPPING WEIGHT:

63 lbs. (29kg.) each